



Operating Manual

Pizza Presser SDP-35

Thank you for purchasing the SUNTEC products.

To ensure best results and use for a long time, it is important that you read, understand and follow these instructions in this manual carefully before using.

This manual should be retained for future reference.





Safety Precautions

The following words and symbols, found in this manual, alert you to hazards to the operator, service personnel or the equipment. The words are defined as follows: **WARNING:** This symbol refers to a potential hazard which could result in serious injury or death. **CAUTION:** This symbol refers to a potential hazard or unsafe practice which may result in minor or moderate injury or product or property damage.



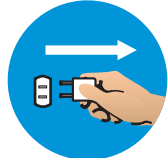
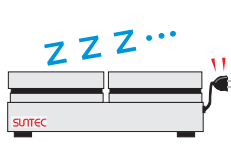

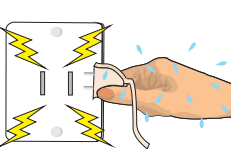



However, indicated **CAUTION** may result in serious condition by situation, it is important that you follow the instruction in this manual carefully.

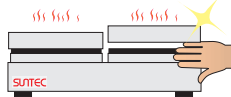
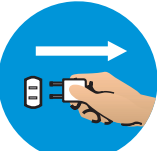
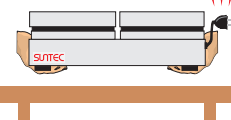

⚠ WARNING

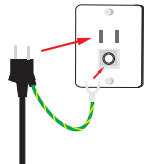
<p>The products which electric power is over 1.0kw must plug a properly (grounded) individual receptacle.</p>			<p>It could result in fire by ignition.</p>
<p>Do not cover the product with a cloth or plastic bag while you are using it.</p>			<p>It could result in fire.</p>
<p>Ensure to unplug the product while you don't use it.</p>			<p>It could result in fire or electric shock.</p>
<p>Do not touch the product with wet hands.</p>			<p>It could result in electric shock.</p>
<p>Never clean the product by sprinkling water.</p>			<p>It could result in electric shock or product damage.</p>
<p>Do not use the product outside in the rain or wet area.</p>			<p>It could result in electric shock.</p>
<p>Use the product in a light place.</p>			<p>It could result in accident or burn if you use it in a dark room.</p>
<p>Do not use the product near flammable gas or liquid.</p>			<p>It could result in explosion or fire.</p>

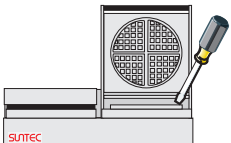

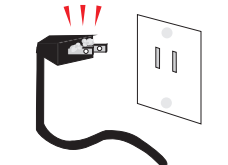



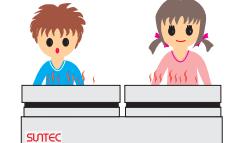

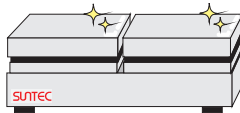

⚠ WARNING

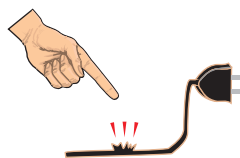
<p>Never touch the plate or around while the product is working because there are very hot.</p>			<p>It could result in burn..</p>
<p>Beware of opening or closing a lid while you are using the product.</p>			<p>It could result in burn or injury by closing a lid.</p>
<p>Ensure to unplug and get cold the product when you move it.</p>			<p>It could result in electric shock or burn.</p>
<p>Must be plugged directly into a properly grounded. (Never connect with gas pipe)</p>			<p>It could result in electric shock by trouble or electric leakage.</p>
<p>Do not overhaul, repair or reconstruct the product except service personnel.</p>			<p>It could result in ignition or injury by unusual performance.</p>
<p>Always clean the edge of a plug when it is dirty or dusty.</p>			<p>It could result in fire.</p>

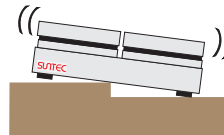
⚠ CAUTION

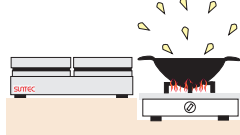
<p>Nobody allows touching the product or cord and keep anyone away from workshop except workers.</p>			<p>It could result in injury or burn.</p>
--	---	--	---

⚠ CAUTION

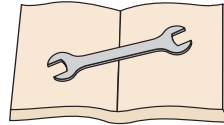
<p>Always keep cleaning the workshop.</p>			<p>It could result in obstruction of safety or efficient work.</p>
<p>Check the supply cord regularly. If it is damaged, it must be replaced with a new cord assembly available from the suppliers agent.</p>			<p>It could result in electric shock or ignition by short circuit.</p>
<p>Place on a horizontal and strong surface at the desired location. Set up with not slipping down.</p>			<p>It could result in injury or burn by the product falls down.</p>
<p>Do not place near water or oil.</p>			<p>It could result in electrical shock, fire, trouble or transformation.</p>
<p>Stop to use the product when it appears smoke, smell or other unusual things.</p>			<p>Contact with the sales agent after turning off the switch and pulling out the plug for preventing trouble or accident.</p>
<p>Be sure to attach this manual, if you hand over the product.</p>			<p>It's necessary that new user works safety and uses correctly.</p>

Before First Use

- Place on a horizontal and strong surface at the desired location. Set up with not slipping down.
- A minimum clearance of 5 cm is required between other equipments.
- Must be plugged directly into a properly grounded. Improper grounding could result in electrical shock or accident. Never connect with gas pipe.
- Don't place near water or oil. It could result in electrical shock, fire, accident or transformation.

Parts Description

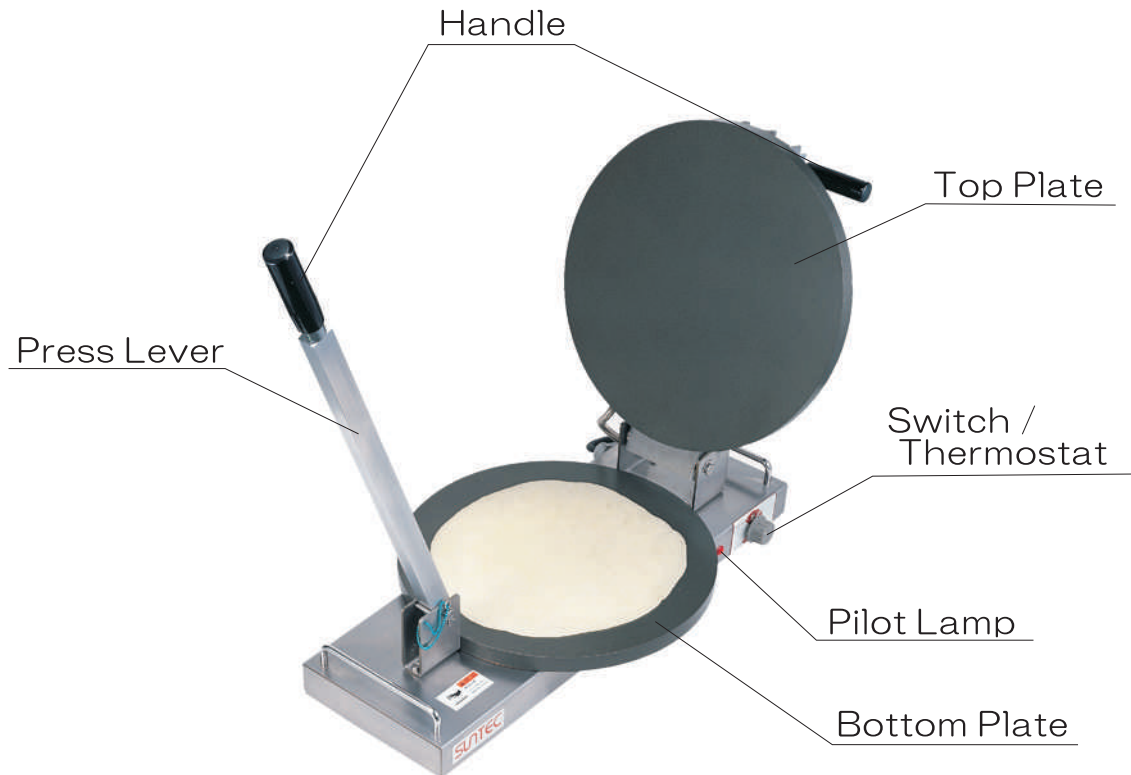

Specification	Pizza Presser
Model	SDP-35
Power	110/220V
Electricity Consumption	1210W
Measurements	350 (W) × 600 (D) × 300 (H)
	Opened Size : 680 (H)
Weight	19kg

Instruction

- 1.Plug directly into a properly individual receptacle.
- 2.Set thermostat / power switch to dial 3-4.
- 3.When it reaches to temperature, a pilot lamp will turn off (It takes about 10-15min.)
- 4.Spread olive oil to dough by brush, (If you use a frozen dough, spread olive oil when you defrost it. It way get dry and not be able to make a circle)
- 5.Put dough on a bottom plate, close a lid and lower a lever to press.
- 6.Take out pressed dough quickly then put toppings on it and bake it by oven.

※This plate is coated teflon, so-Never clean by hard stuff.

※A body and upper plate are very hot,. Do not touch hands or skin, it could result in burn.

※A life of Teflon plates depends on frequency or conditions (the amount of sugar and oil) of using the product, and these need re-coat Teflon at your cost.

Safety

- This product should not be cleaned with water. It's very dangerous.
- Wipe off the product with a dry cloth and always keep clean.
- If the plates don't work sufficiently, contact with your agency. To change the plates is at your cost.
- A warranty should be retained carefully, it's writtn a serial number of the product. This warranty is valid only in Japan. This warranty is invalid to use the product in other countries.
- Should attach a warranty with the product when you order the repair of the product under warranty.
- This manual should be retained carefully for future reference.

How to assemble Pizza Presser

Insert the press lever ① that the pin comes to bottom into the place ② with fitting a place of hole.

Thread a shaft ③ through the hole.

(Switch / Thermostat dial comes a front.)

Lastly insert a pin with band into the hole of toe.

※Don't remove the band when pull out the pin.

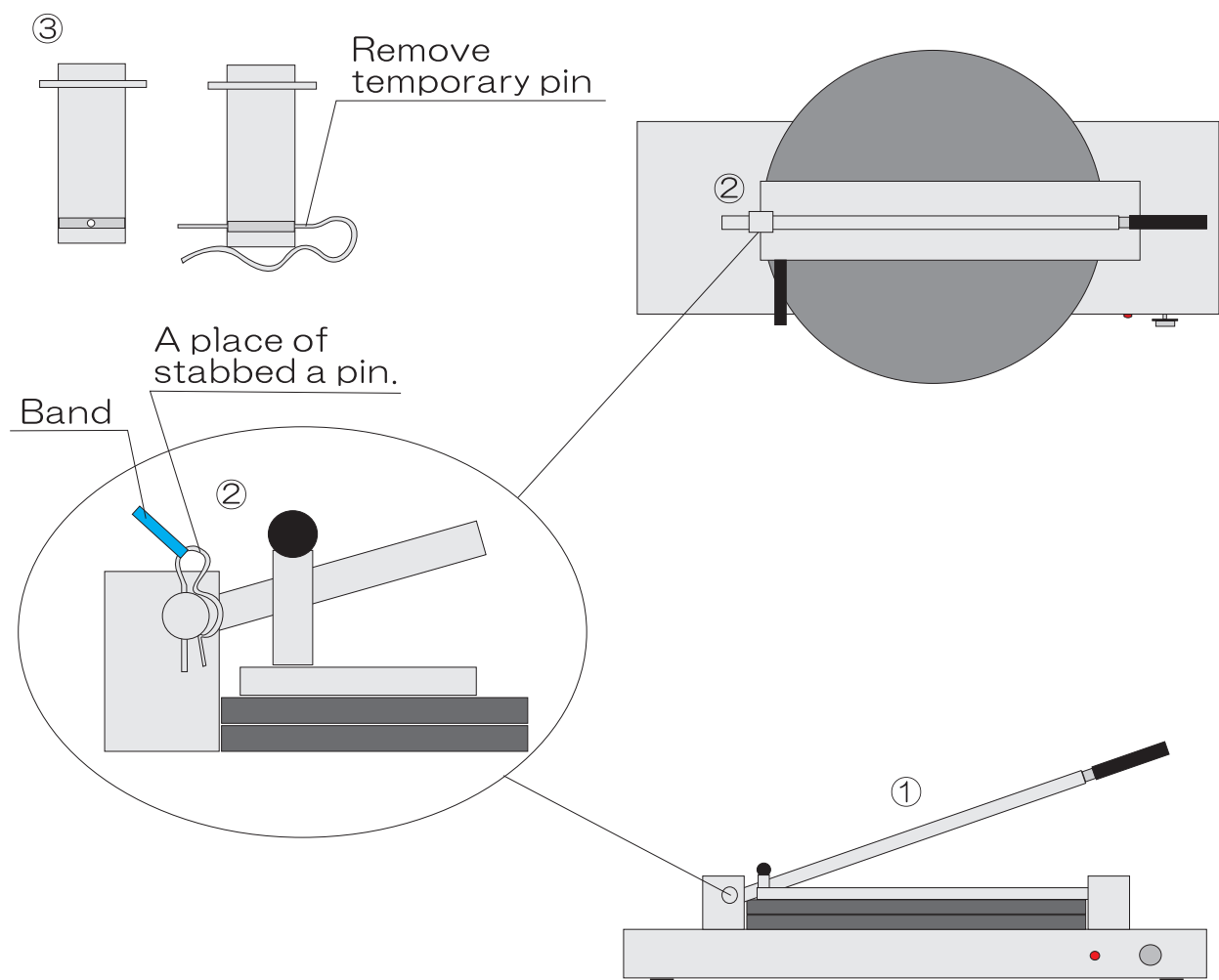

After Service

This product is attached the warranty.
(Excluded Teflon plates)

■ Limited Warranty ———

- Should read and retain the warranty carefully.
This warranty is valid only in Japan.
This warranty is invalid to use the product in other countries.
- The warranty runs for one year from the date of purchasing.

■ Request for Repair ———

- When the product doesn't work well, contact with your agency and request to check the product.
- If it's under warranty, should attach the warranty with the product.
- When you order to repair, should attach a memo which is written a breakdown condition of the product.

SUNTEC

SUNTEC CO., LTD

2-8-12Mukojima, Sumida-ku, Tokyo
131-0033 Japan

Telephon No.81-3-6746-9797
Facsimile No.81-3-6746-9669